

Owner's manual for

Venco

www.venco.com.au

SUPER *twin*

modular system



Supertwin shown making 130mm (5") tiles using the de-airing and expansion chamber module with the roller ramp.

Venco Products

29 Owen Road Kelmscott, Western Australia 6111

ph +61 8 9399-5265 fax +61 8 9 497 1335

email: venwest@inet.net.au

www.venco.com.au

VENCO Super-twin

The Super-twin is an all stainless steel, multi-purpose pugmill. The base unit is primarily used for recycling clay and reclaiming both wet and dry scrap. A series of optional modules are available which are designed for quick, tool-free adaptation of the base unit to perform different tasks such as de-airing and extruding. These modules are available from your Venco dealer.

Optional modules:

De-air module: Converts the base unit into an efficient de-airing pugmill.

Extrusion module: A simple extrusion system allows extrusion of sections up to 80mm (3") wide. Comes with two pre-cut dies and two blanks.

Expansion chamber module: Clips onto the barrel of the Super-twin to facilitate extrusion of more complex or wider sections than the 'extrusion module'. Up to 125mm (5") wide section may be extruded.

Clay ramp: a height adjustable roller ramp allows silky smooth transport of the extrusion from the nozzle. A cutting bow is incorporated into the unit.

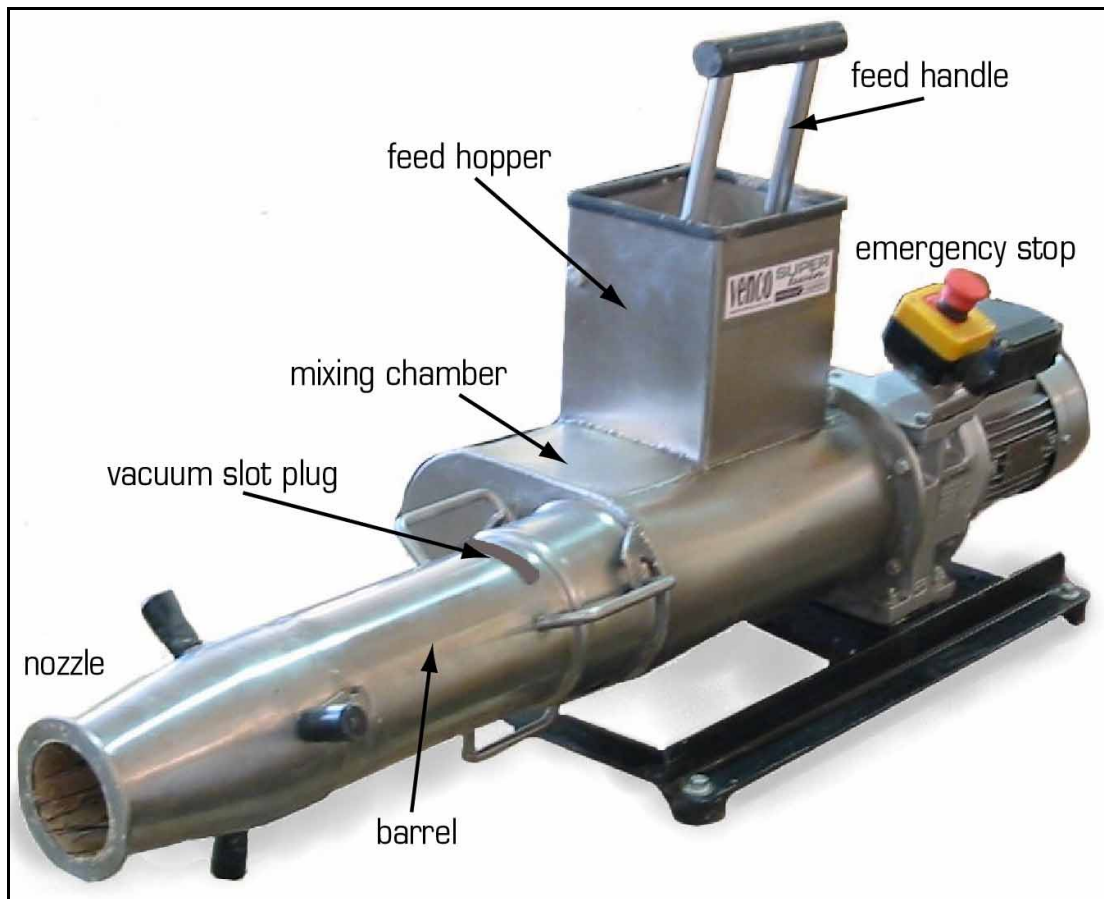

Figure 1: Components of the Super-twin base unit.

UN-PACKING THE PUGMILL

Carefully disassemble the shipping crate and unbolt the pugmill from the wooden baseboard. Locate the four rubber feet and fasten them to the corners of the black frame using a 13mm (1/2") spanner.

The pugmill is insured for the unlikely event of damage during transport. Please report any damage to your supplier.

Important notes

- ❖ The pugmill should be placed on a sturdy table or bench approximately 50cm (20") high.
- ❖ The (optional) vacuum pump may be located up to 7m. (20 ft) away from the Super-twin.
- ❖ The electrical supply should be from a 220-240V, 50-60Hz, single phase 10A outlet. Extension cords and any power boards should be rated at 15A

Hint: Venco use waterproof plywood for the shipping crate. This timber may be re-used to make long lasting batts for your potters wheel.

OPERATION

The Supertwin base unit is shipped fully assembled and ready for operation. These general operating directions also apply when using the optional modules.

More specific operating instructions focusing on the various add-on modules may be found later in this manual.



CAUTION: TURN-OFF UNIT AND REMOVE POWER CORD FROM WALL PLUG BEFORE REMOVING BARREL OR ADDING ANY OPTIONAL MODULES.

Loading the Super-twin

The Supertwin's innovative feed system allows for safe and effortless feeding of clay into the twin mixing augers. This unique design, completely shields the user from the rotating blades without the need for a restrictive safety grille, which is commonly used in traditional lever/pressing systems.

The motor should be left operating at all times while processing clay.



Figure 2: Loading clay

Put lumps of clay onto the ledge in the feed hopper. Pull the lever forward and **hold down for a couple of seconds** to allow the clay to fall off. Lift the handle and repeat the process.

Any resistance that may be encountered is most likely due to over loading with too much clay or lifting the handle before clay has time to fall into the mixing augers underneath.

Hints

- ❖ The pugmill and vacuum pump motors are fitted with overload protection. If either unit trips off, wait for the motor to cool and then press the red reset button located near the on/off switch.
- ❖ When the pugmill is not in use, seal the hopper and nozzle with a plastic bag. This may be made airtight by using an elastic band or some adhesive tape. This will prevent the clay hardening within the unit.
- ❖ Clean out all of the clay if the pugmill is not to be used for over a month. *See maintenance section.*

1) OPERATING THE SUPER-twin BASE UNIT (non de-airing, mixing pugmill)

The Super-twin base unit, is very efficient at mixing, blending and re-claiming both hard and wet scrap clay. Limit the size of dry clay lumps to about 5cm (2") diameter to prevent overloading the unit.

Note: When blending **dry scraps** it is important to **remove the internal shredding screen** that may have been fitted, when in use as a de-airing pugmill (see section 2). Failure to do so will result in rapid clogging of the screen and slow mixing. The vacuum pump should **NOT BE USED** when the shredder screen has been removed i.e. for mixing/blending.

Both hard and wet scraps may be loaded simultaneously. The desired moisture content may be achieved by adjusting the proportions of ingredients and fine-tuning with water or dry clay.

The blended mixture may need to be re-processed a number of times before a homogeneous mix is achieved. Cut pugs of clay in lengths of 5-10cm (2-4") as they exit the nozzle. Continue re-feeding this along with more scrap until the desired mixture and consistency has been reached for the complete batch. If dry scrap is being blended it may require three or four passes through the unit to achieve a smooth uniform body.

HINT: When blending dry scraps or broken greenware with slip or clay it is a good idea to remove the nozzle. This reduces the load on the pugmill while it is blending and crushing the hard scraps - as it is not important to compact the mix at this stage. Refit the nozzle only when the mixed clay is homogeneous and the consistency is correct.

Water can also be added to the mixture in the hopper – it is best added with the feed bucket in the closed position. With practise, dry powder clay may also be added to the mix. If attempting this, it is advised to add the powder or water in small amounts.

Only after you are satisfied with the consistency of the body (and there is no dry scrap within the mix) should the screen be fitted and the vacuum pump turned on. The complete batch may then be de-aired using the de-air module and stored for use.

2) USING THE DE-AIR MODULE (de-airing pugmill)

The Super-twin can be quickly converted to a de-airing pugmill by the addition of the 'de-air module'. The components of this kit are shown below.



Figure 3: The vacuum module.

Fitting the de-air module

a) Installing the shredder screen

- 1) Firstly remove the barrel as described in the 'maintenance section'.
- 2) Locate the shredding screen and locking plate. Slide out the locking plate from the slot in shredder screen. The screen is fitted onto the auger shaft immediately adjacent to the mixing chamber. It is important that the screen be fitted the correct way around – the mesh side must face the motor/gearbox (hollow side to face nozzle). The notch in the screen fits over the auger shaft. Slide the locking plate into the groove as shown below. Sliding the locking plate under the outer ring of the screen securely retains it.
- 3) Refit barrel as described in the maintenance section.

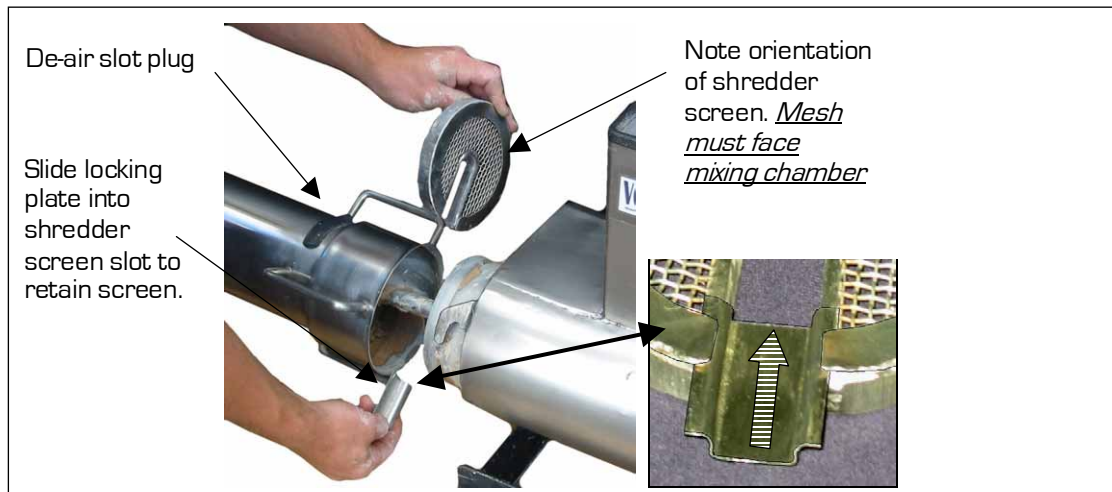

Figure 4: Fitting the shredder screen (note orientation)

b) Connecting the vacuum pump to the vacuum chamber

- 1) Apply a small amount of grease onto the brass threads. Screw the filter / water trap onto the on the vacuum pump. The clear bowl should face downward, as in Figure 5.
- 2) The black hose connects the vacuum pump to the vacuum chamber. Connect one end to the vacuum pump filter and the other to the fitting next to the vacuum gauge on the vacuum chamber. Use a 16mm (5/8") spanner to tighten.

Note: The procedure described in (b) above need only be done when setting up the module. It should be left assembled and simply clipped onto the barrel when needed, thus requiring no tools.

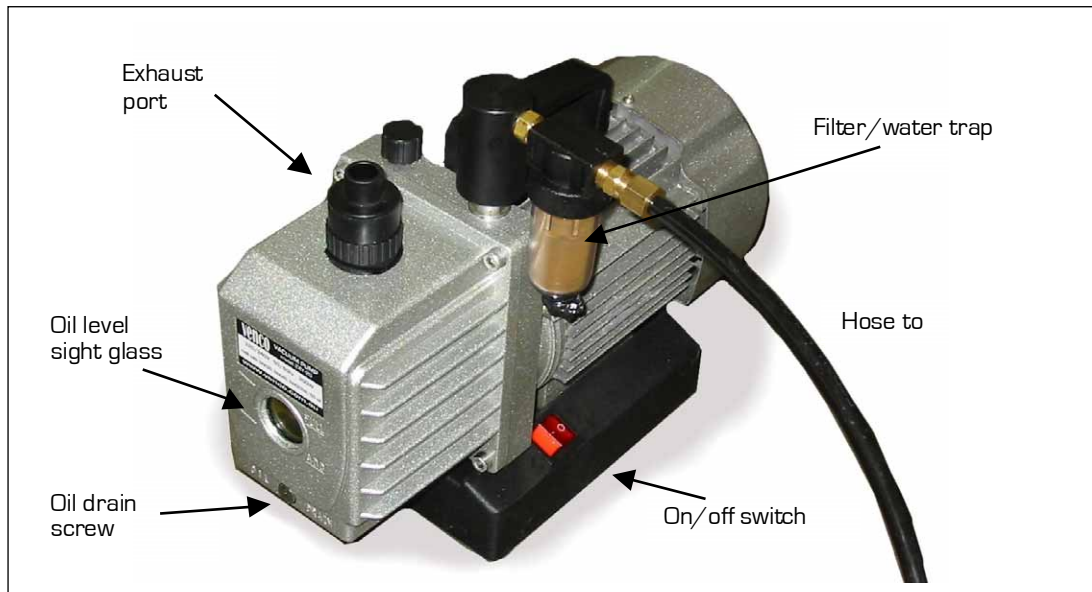

Figure 5: Vacuum hose and filter location on the vacuum pump

Hint: A small amount of grease on the threads of the fittings will aid sealing.

c) Fitting the vacuum chamber

- 1) Remove the rubber de-air slot plug, located between the barrel removal handles. Lift at one corner and peel back to remove.
 - 2) The vacuum chamber is to be fixed to the barrel, over the vacuum slot. An elastic cord loops under the barrel to secure it.
- Two gaskets need to be fitted onto each open face of the vacuum chamber;
- i) between the barrel and the vacuum chamber
 - ii) between the clear lid and the vacuum chamber

Note:

Ensure the gaskets fully seal the edges of the stainless steel vacuum chamber. The gasket should be visible both on the inside and outside perimeter of the sides of the vacuum chamber. This will ensure a good seal.

- 3) The vacuum chamber must be positioned to completely cover the de-airing slot in the barrel. To achieve this, one edge of the chamber should be positioned against the barrel ridge adjacent to the slot. See figure 6.

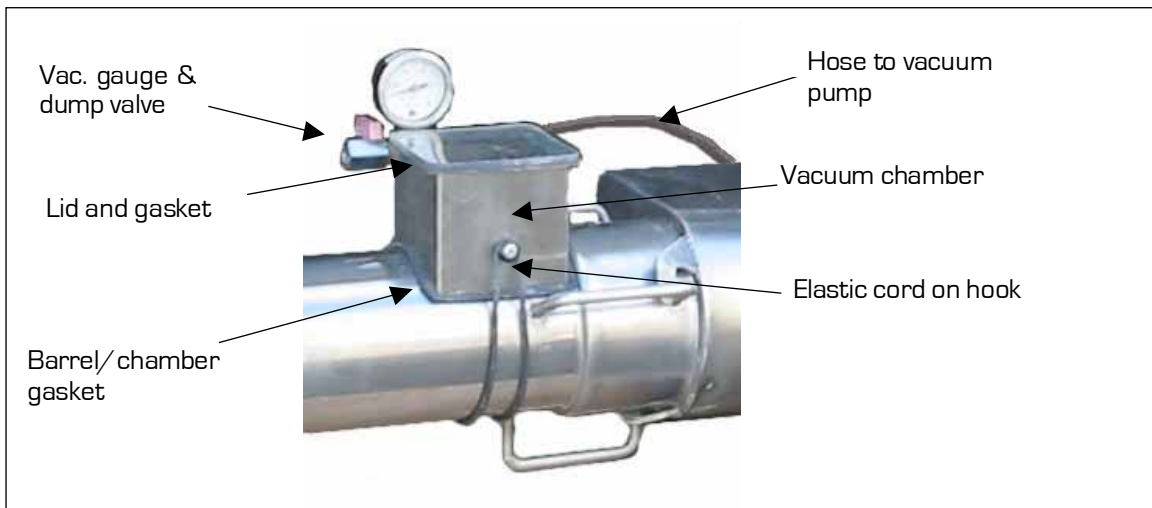

Figure 6: The vacuum chamber fitted to the barrel.

Note:

- The elastic cord need not be very tight to retain the vacuum chamber or to make an effective seal. With the lid fitted and the two gaskets in place, the applied vacuum causes the chamber to rigidly grip onto the barrel.
- The unit will not achieve a vacuum until clay is being processed.
- The shredding screen **MUST BE FITTED** when the Super-twin is used for de-airing clay.

d) Using the Super-twin as a de-airing pugmill.

- ❖ Leave the vacuum pump running continuously while pugging. The pugmill itself may be briefly turned on and off as required for cutting the pug etc. (If the vacuum pump is turned off during pugging, the clay within the barrel may absorb air.)
- ❖ Air is drawn from the clay through the de-air slot in the barrel. It is normal for some of the clay to be sucked up through the slot and into the vacuum chamber during operation. This clay need only be removed if the chamber becomes full or if the slot becomes completely blocked.
To successfully de-air clay, there need only be a small hole from the vacuum chamber into the pugmill barrel.

Hint: The de-airing slot can be cleared *swiftly* by quickly flicking the vacuum dump tap on and off while processing.

- ❖ For satisfactory de-airing the vacuum gauge should read 90kPa or more. 95-98kPa is ideal.
- ❖ Some fine porcelain type clays are difficult to de-air. To improve de-airing, slow the rate of flow by blanking off the top of the shredding screen, adjacent to the de-airing slot. This may be accomplished by applying a layer of plastic adhesive tape to the top layer of the screen. See figure 4.
This technique may also be used to reduce the clay flow through the slot into the vacuum chamber if this becomes a problem with soft clays. Install with the blanked area immediately beneath the de-airing slot. Do not blank off more than 50mm (2") of screen height. See the maintenance section for information on removing the shredding screen.

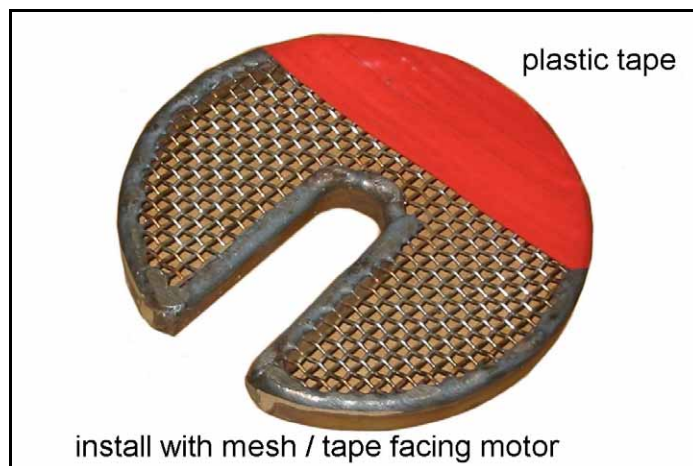

Figure 7: Blanking off the shredder screen

❖ It is important to check the vacuum pump oil level and condition weekly. *See the maintenance section for more information.*

3) USING THE EXTRUDER MODULE

The Super-twin can be adapted to make extrusions using the Extruder Module. This kit contains a die holder, which is fitted to the end of the barrel replacing the standard barrel nozzle. The die set comprises four dies; an 80 x 12 mm (3" x 1/2") tile die, a 50mm (2") solid and two blank dies for user customisation.

The Extruder module should be used in conjunction with the De-air module to produce perfectly de-aired sections.

The extruder module may be used to produce sections up to 80mm (3") in width. For wider shapes the Expansion chamber module will be required.



Figure 8: The Extrusion kit

a) Fitting the Extrusion module

1) Turn off the Super-twin and remove the power cord from the outlet. Remove the standard barrel nozzle by gripping the handles and rotating in a clockwise direction (looking into the barrel) until the clips rotate away from the barrel pegs.

2) Clean any clay from the end of the barrel and inside the die holder. Smear a liberal coating of petroleum jelly onto the mating surfaces.

3) Place the desired die into the die holder and fit the assembly to the barrel where the nozzle was previously. Ensure the retaining hooks are fully locked onto the three barrel pegs.



Figure 9: Fitting the Die Holder to the barrel

b) Custom making extrusion dies

Custom dies may be home made from plexi-glass or plywood 10mm (3/8") thick. Making dies, particularly for complex shapes, may take some experimentation. It is important not to make too small an orifice as this may overload the pugmill. As a rule-of-thumb use a minimum area of 10cm² (1½in²). Overloading is apparent if clay back-feeds into the vacuum chamber at a high rate. Extreme overloading may result in the motor running hotter than normal or may cut out on thermal overload. These events should be avoided by designing a larger extrusion cross-section or by cutting multiple smaller openings to increase the available area.

1) Firstly cut the disk the required diameter to fit into the die holder. (118mm, 4 5/8" diameter)

2) Draw the required cross section of the extrusion onto the blank die plate (remember to allow for shrinkage when drying) and cut it out with a small craft saw or drill/file the opening. Use fine sand paper to carefully sand the cut edge smooth. Radius the corners of the die opening, on the side where the clay pushes. Smoothing these corners will promote even clay flow and produce a better extrusion.

3) Trial the die. You may experience differential flow (clay flowing at different speeds) across the width of the extrusion. This may be due to the shape of the extrusion (a wide shape with narrow edges for example) or caused by an extrusion nearing maximum width. Some differential flow is OK but it will depend on the product. Trial and error will provide the best results.

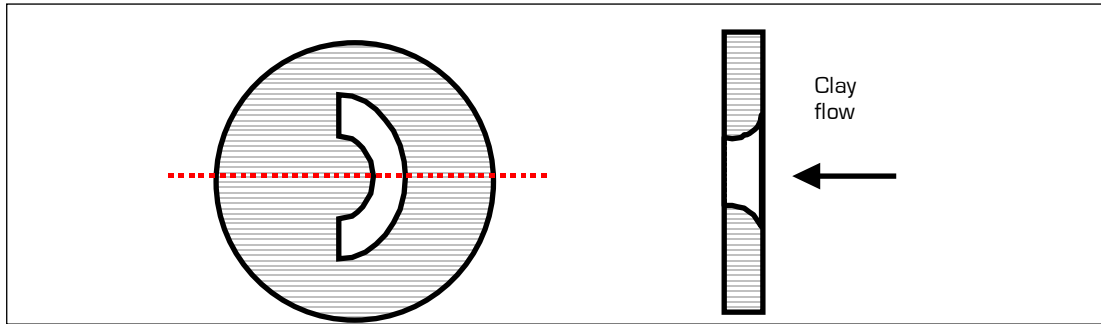

Figure 10: Custom made die plate example showing radiused entry.

c) Using the Extrusion Module

With the die and die holder fitted securely to the barrel, start the Super-twin and vacuum pump. Feed clay of the required consistency until the extrusion is produced. For best results the Roller ramp may be used to smoothly carry the extrusion away and prevent damage over its length. The pugmill may be briefly turned off (leave the vacuum pump on) to cut the extrusion with a wire, without compromising clay quality.

4) USING THE EXPANSION CHAMBER MODULE

The Expansion chamber further increases the flexibility of the Super-twin when used as an extruder, allowing sections of up to 150mm (5") in width to be created. Like the Extruder Module the expansion chamber is simply clipped onto the barrel in place of the standard conical nozzle.

Due to the countless extrusion sections that may be created, the Expansion chamber module comes without dies. See below for advice on making these simple die plates.

The Extruder module should be used in conjunction with the De-air module to produce perfectly de-aired sections.



Figure 11: The Expansion chamber

a) Fitting the Expansion Chamber

1) Turn the Super-twin off and remove the power cord from the outlet. Remove the standard barrel nozzle by gripping the handles and rotating in a clockwise direction (looking into the barrel) until the clips rotate away from the barrel pegs.

2) Clean any clay from the end of the barrel and the mating section of the expansion chamber. Smear a liberal coating of petroleum jelly onto the mating surfaces.

3) Fit the assembly to the barrel where the nozzle was previously. Ensure the retaining hooks are fully locked onto the three barrel pegs.

b) Custom making dies for the Expansion Chamber.

Die plates can be made from plywood or plexi-glass at least 12mm (1/2") thick, preferably 16mm (5/8"). The die plate should be cut at least the same diameter as the flange on the front face of the expansion chamber to ensure a good seal. The die plate may either be bolted to the expansion chamber or clamped on using wood working G-clamps.

Please follow the same instructions as for the Extruder module section 3b, regarding shaping the die plate and using dies.

5) USING THE CLAY RAMP

A stainless steel, roller-bed style clay ramp is available to support and carry away the extruded body upon exit from the Super-twin. A cut-off bow is incorporated into the ramp to allow easy cutting of the extrusion. The height of the rollers may be easily adjusted to the appropriate height to cater for different section extrusions. The roller bed is 350mm long x 140mm wide (13" x 5") and the height can be adjusted from 70mm to 240mm (2.75" - 9.5")

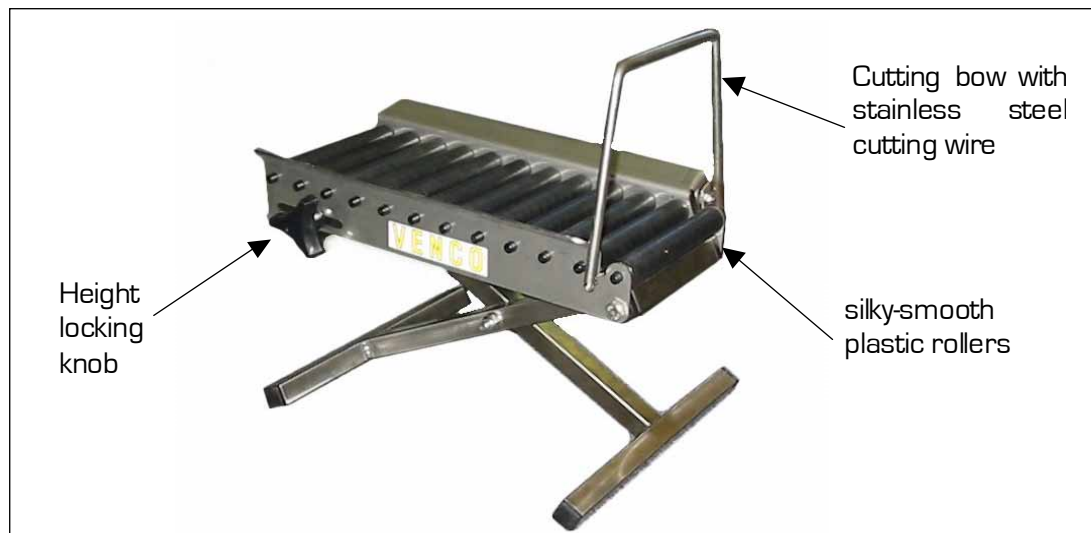

Figure 12: Height adjustable clay ramp

a) Using the Clay ramp to make tiles

This step-by-step procedure shows the Super-twin making 130mm x 15mm (5" x 5/8") tiles using the expansion chamber & hand-made wooden die.



STEP 1

Extrude a small amount of clay and adjust the height of the rollers until the extrusion level is horizontal. Ensure that the clay ramp is exactly straight along the pugmill barrel and central with the extrusion.
Extrude a length of 'tile' beyond the cut-off wire and stop the pugmill. Using the cut-off bow, cut the extrusion.



STEP 2

Place a ruler on the cut edge of the extrusion and measure the length of tile required. Using a marker pen, put a mark on the angled sides of the ramp. It is best to put a mark on both sides of the ramp.



STEP 3

Extrude clay until the edge lines up with the marks, then turn-off the pugmill (not the vacuum pump). Cut the tile using the cut-off wire -this may be used in either direction. When cutting in the 'up' direction, gently support the tile with your fingers.
Note: Do not lift the cut tile from the rollers - it may be bend or damaged.



STEP 4

Ensure the cut-off wire is either in the fully-up or fully down position. Start the pugmill and extrude until the freshly cut edge lines up with the marks on the roller ramp - as in step 3.
Turn-off the pugmill, when the mark is reached, and cut as before.



STEP 5

Repeat step 4 until the tiles reach the end of the clay ramp. As they move over the edge lift them off gently.

MAINTENANCE

Pugmill maintenance

Venco pugmills are designed to be extremely robust and should reward you with many years of trouble free operation. To ensure this, please follow these few simple procedures.



CAUTION: Before performing any maintenance turn off the pugmill and un-plug the power supply cable.

Removing the barrel

The Super-twin is designed for quick and easy barrel removal to enable cleaning or fitting/removing the shredder screen. Tools are not required.

- 1) Turn the pugmill on and run out all clay from the mixing chamber.
- 2) Once empty turn-off the pugmill and un-plug the power cord from the power outlet.
- 3) Grasp the barrel handles firmly and twist in a clockwise direction (viewed from the nozzle end). Twist until the handles come free from the hooks on the mixing chamber.
See figure 13
- 4) Once the handles are disengaged slide the barrel down the auger and remove.

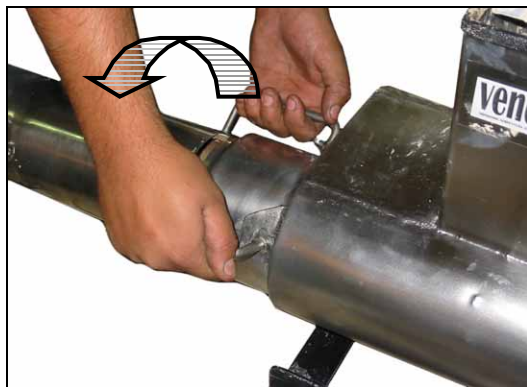

Figure 13: Removing the barrel - step 1

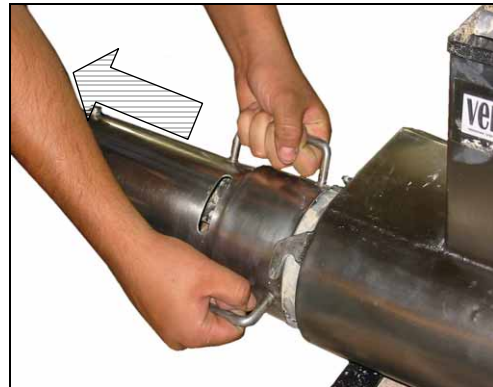

Figure 14: Removing the barrel - step 2

Hint: If the barrel is difficult to slide off the auger due to dry clay etc. continue rotating in a clockwise direction to screw the barrel off the auger.

Replacing the barrel.

Fitting the barrel is simply the reverse of the removal procedure. Rotate the barrel firmly to make sure that that it is secure. Before re-fitting the barrel ensure that all clay is cleaned from the mating sections, especially the short 'neck' protruding from the mixing chamber and the corresponding expanded part of the barrel. Coat this neck with petroleum jelly to make future removal easy.

Hint: Apply a liberal smear of multi-purpose grease or petroleum jelly onto the 'neck' protruding from the mixing chamber before assembly. This will aid future removal.

Note: The barrel should be fitted with the de-airing slot facing upwards.

Cleaning the shredder screen (de-air module)

The de-airing shredder screen, mounted within the pugmill barrel, may in time, become blocked with grit or other impurities carried with the clay. The barrel must be removed to access the screen for removal and cleaning. See section 2 'The De-air module' for further information.

Hint: An optional coarse shedding screen is available for use with coarse terracotta or clay containing large amounts of grog.

Checking/changing gearbox oil

The pugmill gearbox is filled with high quality, industrial, synthetic gear oil. Under normal operating conditions this oil will never need changing.

Removing the Mixing chamber.

DIS-CONNECT POWER BEFORE PROCEEDING

On occasion the mixing chamber may need to be removed to clean out dried clay or if a new body is being used. It should be noted that removal of the mixing chamber would be a rare occurrence.

To remove the mixing chamber, first remove the nozzle and barrel. There are seven (7) bolts around the mixing chamber flange that need to be removed using a 13mm (1/2") spanner. Only remove these OUTER 7 bolts, then draw the mixing chamber off the augers.

Replacement is the reversal of the above procedure.

Vacuum pump maintenance

It is important to check the vacuum pump oil level **weekly**. As the pump operates some oil vapour is exhausted. This is normal and beneficial in keeping the pump mechanism lubricated and free from corrosion.

The vacuum pump has a sight glass to check the oil level. Check level is never far below the max. The vacuum pump should be topped up with SAE30, SAE40 or multigrade 20/40 engine oil. DO NOT use friction-modified oils.

The vacuum pump filter/water trap should be checked occasionally. Clean and drain, by unscrewing the clear plastic bowl. Apply a thin layer of grease or petroleum jelly to the thread on the bowl to aid sealing and future disassembly.

Hint: Some clays shed water during the de-airing process. This can be carried back to the vacuum pump as vapour. This mixes with the sump oil, turning it cloudy white. If this happens, drain the oil into a glass jar and replace with new oil. The old oil can be re-used after it separates from the water (the oil will float on top of the water).

SUPER-TWIN TROUBLE SHOOTING GUIDE

Symptom	Problem Description	Remedial Action
VACUUM PUMP	water mixed with oil	drain oil from vacuum pump and replace with fresh oil. Contaminated oil will eventually separate and oil may be drained off and reused.
milky / cloudy oil		check oil level in vacuum pump, wait for motor to cool before restarting if problem persists see your supplier
motor stops running	overload trip	clay feed into pug too slow -increase feed rate. for more details see below.
low/fluttering vacuum	vacuum leak or vacuum pump problem	
PUGMILL		
motor stops running	overload trip	overloading the pugmill, wait for motor to cool before restarting
excess effort needed to operate feed bucket	clay blocking mechanism or clay pressed against hopper	feeding too fast before clay has time to fall into augers. Turn off pugmill and use scraper to scrape built-up from hopper walls. If adding water it is best to add while the bucket is in the closed position to minimise sticky surface on hopper parts.
excess clay being pushed into vacuum chamber	bridging of vacuum slot	clay too soft - change consistency or try blanking shredder screen as described in manual flow rate too high - reduce feed rate. If using dies -apperture maybe too small, increase size. flick vacuum dump tap open/close quickly to suck clay away.
reduced clay output	blocked shredder screen	disassemble barrel and remove and clean shredder screen Note: dry turnings will quickly block the screen -wet and ball before using
no output even when motor is running	coring of clay within barrel	feed with drier clay and leave running until clay starts feeding again. Coring is caused by too much water being added to drier clay in one step. Add a little at a time.
air in clay (de-air models only)	loss of vacuum note: gauge should read more than 90KPa	* vacuum pump must be operated continuously while pugging * Remove plastic vacuum chamber lid and place finger over brass inlet within vacuum chamber while pump is operating. If this restores vacuum reading on gauge then the problem lies with the vacuum chamber lid gasket or with the barrel gasket - see note (a). * Check all fittings for tension, remove and grease threaded connections * Check plastic vacuum chamber lid for distortion -order new lid * If after checking the above, it is possible that the vac. pump needs servicing please contact your dealer for advice. See note (b)
Notes:		
(a)	check condition of black gasket under vacuum chamber lid and barrel-vacuum chamber- replace if worn or damaged. the vacuum chamber must be placed over the vacuum chamber slot (remove rubber plug first).	
(b)	A simple method of isolating and testing the vacuum pump alone is to fit the vacuum gauge directly to the inlet of the pump. This may be done by using additional fittings or a short piece of rubber hose (and two hose clamps). The gauge must be read in a vertical position.	

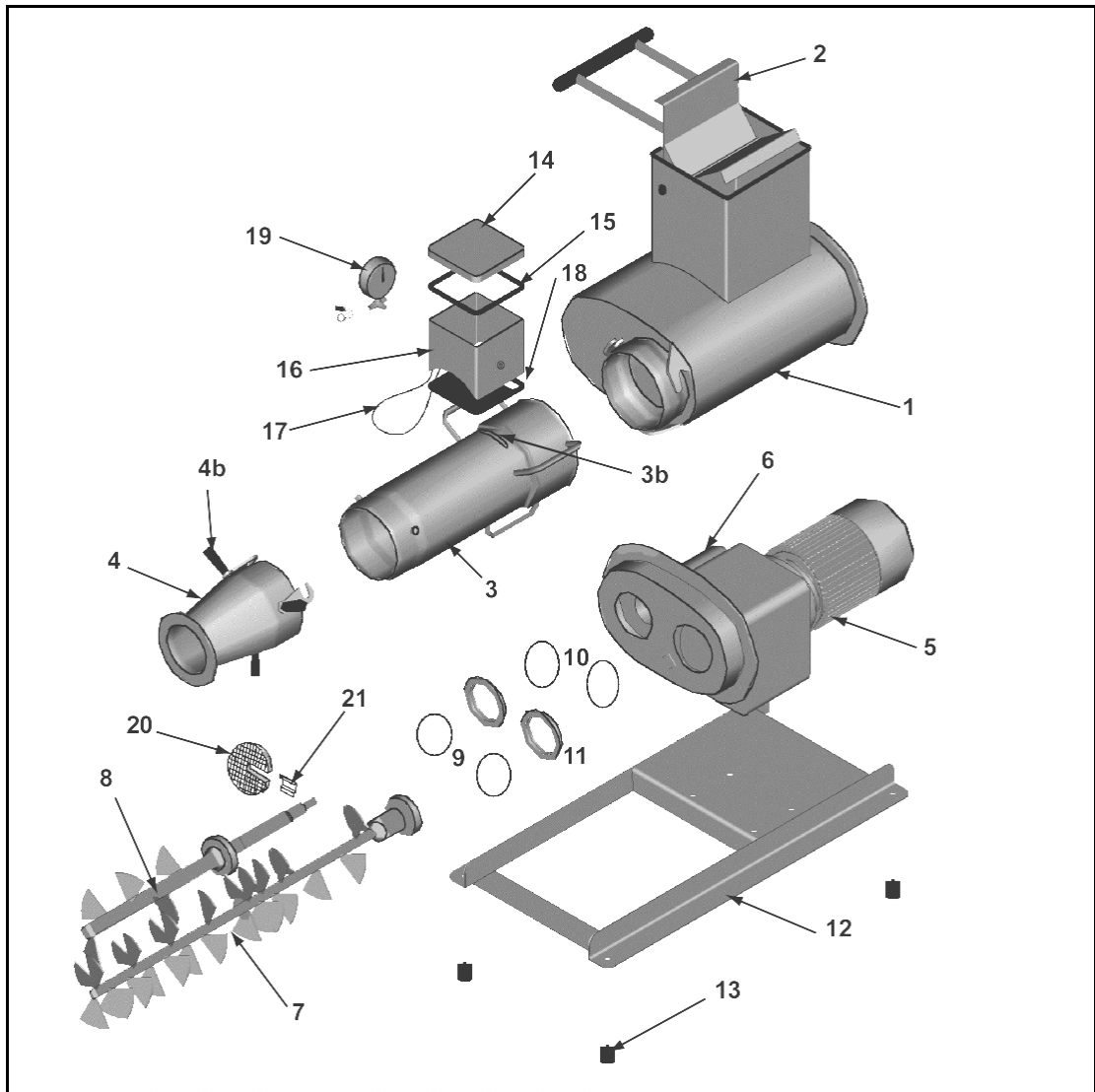

Venco SUPER-twin PARTS LIST

- | | |
|--------------------------------------|--|
| 1. mixing chamber | 2. feed 'bucket' and handle |
| 3. main barrel | 3b. vacuum slot plug |
| 4. standard nozzle (80mm) | 4b. nozzle handles (x3) |
| 5. motor and gearbox | 6. mixing auger bearing housing cap |
| 7. primary auger | 8. mixing auger |
| 9. auger o-rings | 10. retaining o-rings |
| 11. auger seal ring | 12. base assembly |
| 13. rubber feet (x4) | 14. vacuum chamber lid (de-air odule)* |
| 15. vac. chamber lid gasket * | 16. vacuum chamber * |
| 17. vacuum chamber holding strap* | 18. vacuum chamber/barrel gasket* |
| 19. vacuum gauge, brass 'T', valve * | 20. shredder screen * |
| 21. shredder screen locking plate * | |

Other ceramics equipment available from Venco:



No.6 Cone drive potters wheel. High quality budget priced wheel with integrated seat.



No.3 Cone drive potters wheel.



No.5 Cone drive potters wheel with hand operated speed lock



No.7 High torque, electronically controlled potters wheel

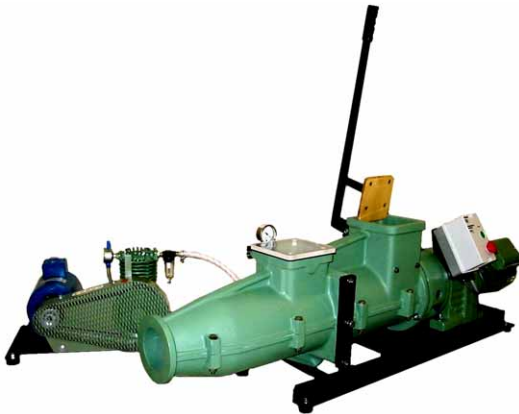

87mm and 100mm (3 1/2, 4") de-airing pugmill



Hand operated stainless steel hand extruder

INDUSTRIAL series



INDUSTRIAL SERIES

All stainless steel, high capacity de-airing pugmill with mechanical variable speed drive. 200 or 262mm (8" or 10" barrel) Self feeding with various options for commercial production. Production capacity up to 4000kg/hr (8800lb/hr)

VENCO – world renowned for quality and reliability